

Owners Manual

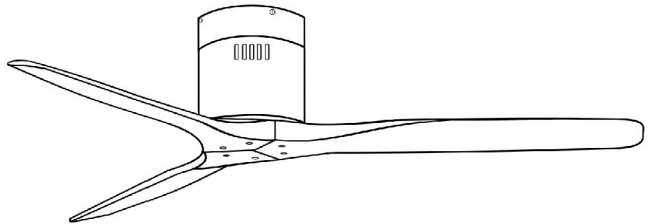
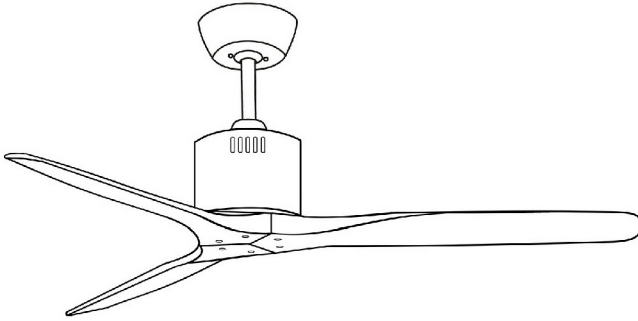

MODEL: KEN

CAUTION

READ INSTRUCTIONS CAREFULLY FOR SAFE
INSTALLATION AND FAN OPERATION.

Suitable for 220V/50Hz electrical supply

SAFETY INSTRUCTIONS

To reduce the risk of fire, electrical shock, or injury to persons, please observe the following:

1. Read all instructions and safety information before installing. This manual is not intended to instruct or assist untrained or unqualified persons. It is the responsibility of qualified, licensed installer, and user to apply common sense and care at all times during installation and operation.
2. This appliance is not intended for use by children or persons with reduced physical, sensory or mental capabilities, or lack of experience and knowledge, unless they have been given supervision or instruction concerning use of the appliance by a person responsible for their safety.
3. To avoid possible electric shock, be sure electricity is turned off at the main power box before wiring. Make sure electrical voltage and frequency is within the control capacity range.
4. Please make sure the location has stable power supply, with temperatures between 10°C to 40°C and that the ceiling fan is not exposed to direct sunlight, humidity, or wind blow over a long period of time.
5. Ceiling fan must be installed at least 2.5 meters above the floor. Make sure that your installation area will not allow rotating fan blades to come in contact with any object when fan is in operation.
6. The mounting bracket must be firmly screwed to a strong ceiling support such as a concrete ceiling, steel structure, or a timber frame. If additional timber frames are to be added, those must be securely nailed or screwed between the beams. All support must be able to withstand motion of the moving fan and weight of at least 120 kg.
7. For safety regulation, the safety cable must be secured firmly with the mounting bracket or with a separate anchor bolt with hook, which must be able to withstand motion of the moving fan and weight of at least 120 kg.
8. After fan is completely installed, check to make sure that all connections are secured to prevent fan from falling and/or causing damage or injury. Refrain from using product in case of abnormalities, stop operation immediately and contact MR.KEN service center for help and support.
9. Condition of the ceiling fan, including all parts and suspension/support system, should be checked annually by qualified technicians or authorized personnel. Any alterations or replacements of any parts of the product must only be carried out by authorized personnel by MR.KEN service center.
10. Maintenance and cleaning of the ceiling fan should be carried out annually by qualified technicians or authorized personnel to ensure the normal functioning and prevention of damage to fan motor. Please exercise caution when cleaning so as to not cause bending of the blades, as it may result in damage or breakage of the product. Do not soak or expose product to chemical solvents that could cause discoloration or deformation of the product. Please contact MR.KEN service center for customer support and inquiries.

⚠ WARNING: This product is designed to use with only those parts supplied with this product and/or accessories designated specifically for use with this product. Using parts and/or accessories not designated for use with this product could result in personal injury or property damage.

⚠ WARNING: The company will not be responsible for any accidents and injuries caused by incorrect installation or modification that is not instructed by this manual.

PARTS LIST

Unpack and inspect fan carefully to be certain all contents are included.

• SOLID-DR

Mounting Bracket

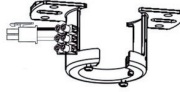

Downrod Assembly



Canopy

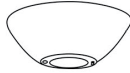

Fan Assembly

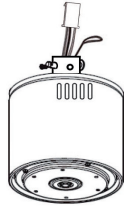

Hardware Bag

Wood Screw	x 2	
Bracket Screw	x 2	
Blade Screw with	x 6	
Spring Washer	x 6	
Lock Washer	x 6	
Rubber Tube	x 6	
Balanced Slice	x 1	
Weight Block	x 3	

Fan Blade

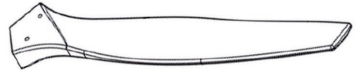

Remote control



• SOLID-HR

Fan Blade



Mounting Bracket



Remote control



Fan Assembly



Hardware Bag

Wood Screw	x 4	
Bracket Screw	x 4	
Blade Screw with	x 6	
Spring Washer	x 6	
Lock Washer	x 6	
Rubber Tube	x 6	
Balanced Slice	x 1	
Weight Block	x 3	

DOWROD INSTALLATION (FOR DR MODELS ONLY)

● Installing Downrod and Yoke

1. Remove the pin and ball screw from the downrod assembly, then remove the downrod ball. Remove cotter pin and cross clip from the yoke and loosen the downrod jam screw at yoke.

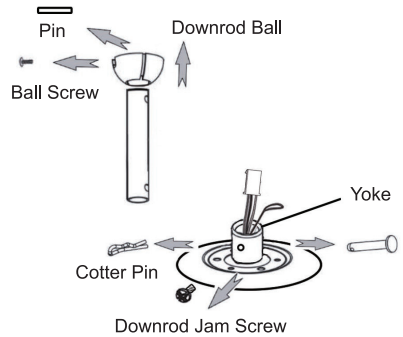

2. Insert downrod through canopy and yoke cover, and feed motor lead wires through downrod.

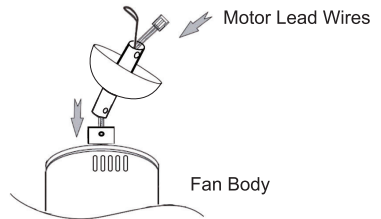

3. Reinstall the downrod ball on the downrod.

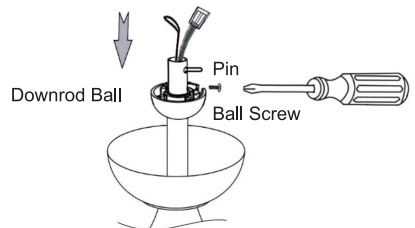

4. Insert the cross pin through yoke & downrod. secure with cotter pin. Tighten downrod jam screw to further secure downrod.

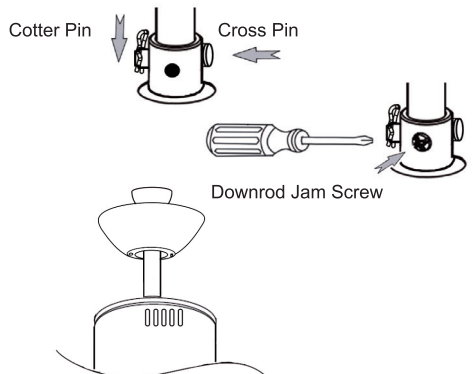

EXTENSION SAFETY CABLE CONNECTION (OPTION)

Note: Each new downrod is packed with one new safety cable. One end of which is looped with copper ring and the other one is looped with clamp end.



1. Insert the original safety cable through the copper-ring end loop of the new safety cable by following the directions as shown in the picture below.
2. Insert the new safety cable through the loop of the original safety cable from the fan by following the directions as shown in the picture below.
3. Pull straight and make both loops cross tightly. Then make sure all clamp screws are fastened.

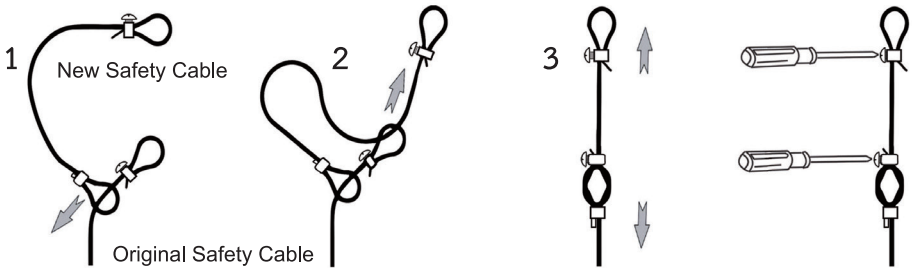

DR CEILING JOINT

1. Secure the mounting bracket to the ceiling joint or structure that is capable of carrying a load of at least 30kgs with 2 wood screws provided. One of wood screw set is fully tightened. The other one is screwed as shown.

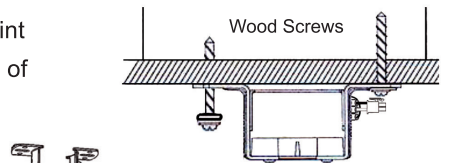

2. Lift fan assembly onto mounting bracket. Rotate fan so that the groove on the ball engages the ridge in the mounting bracket.

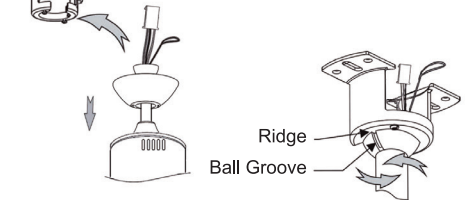

3. Hook safety cable to the wood screw. Then fasten the Clamping Screw tightly

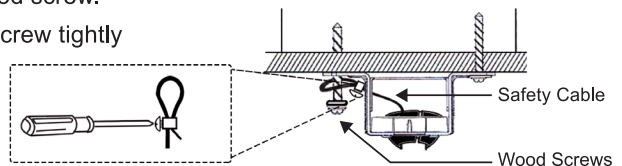

4. Ensure all wood screws are fully tightened.

WARNING:
For safety regulation, the safety cable must be fastened on mounting bracket or with separate hook firmly

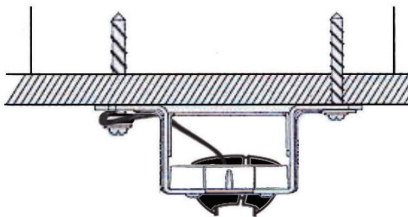

HR CEILING JOINT

1. Secure the mounting bracket to the ceiling joint or structure with 4 wood screws provided. 3 of wood screw sets are fully tightened. The other one is screwed as shown.

2. Hook the fan body onto the HR mounting bracket as shown. Hook safety cable to the wood screw, then fasten the clamping screw tightly.

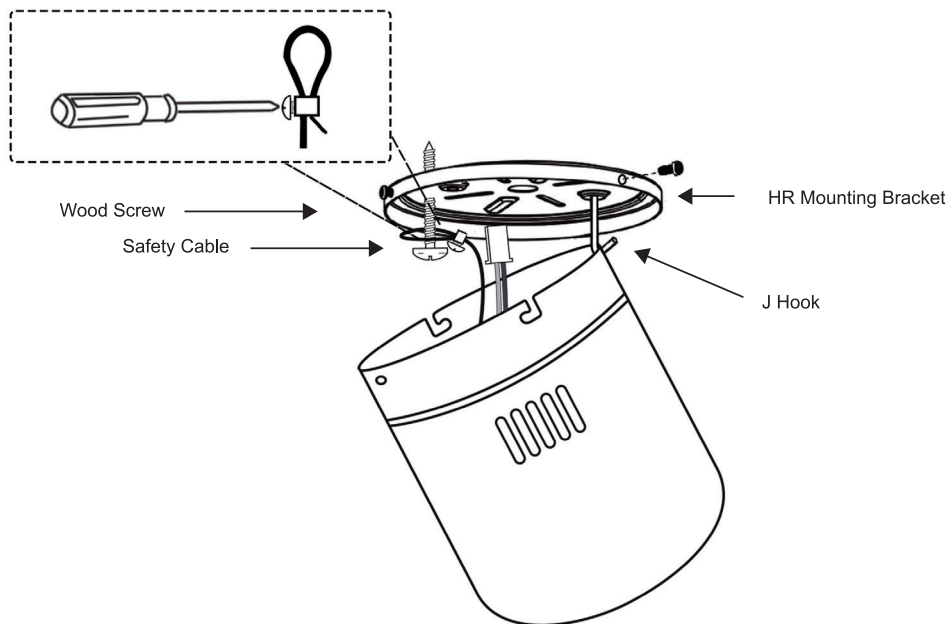

WIRING INSTRUCTIONS

Note:

Turn off power at breaker box to avoid possible electrical shock.

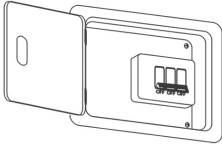

⚠ WARNING

To avoid fire or shock, follow all wiring instructions carefully. Any electrical work not described in these instructions should be done or approved by a licensed electrician.

⚠ WARNING

Do not operate this fan with a variable (Rheostat) wall controller or dimmer switch. Doing so could result in damage to the ceiling fan's remote control unit.

Follow diagram below and make sure that all exposed wires are secured inside terminal block.

Note: Wires from house may vary in color.

1. Connect the household live wire to the other side of terminal block marked "L" .
Secure the wire with screw driver.
2. Connect the household neutral wire to the other side of terminal block marked "N" .
Secure the wire with screw driver.
3. Connect the the fan earth wire () to the terminal block.

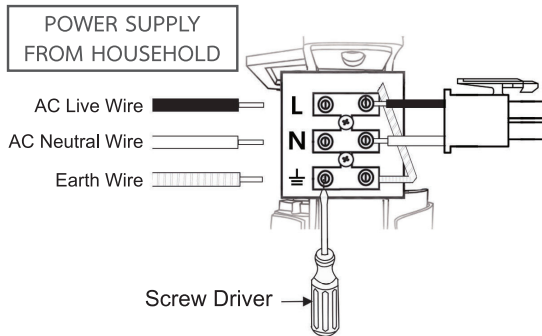

4. Connect the power lead wire from the bracket to the motor wire by 4P connector.

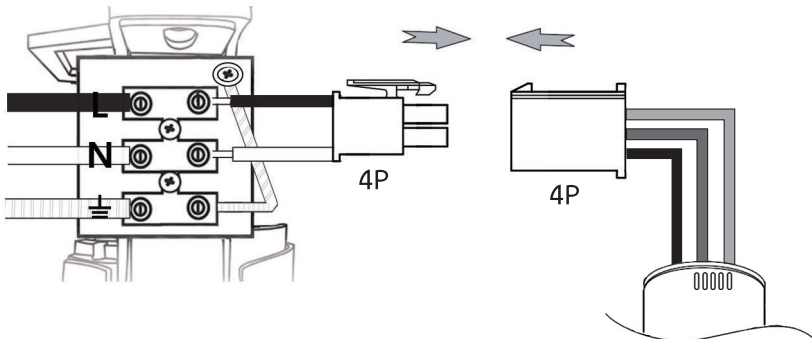

CANOPY INSTALLATION

● Canopy Installing for DR Models

1. Loosen 2 screws with hex nut from the bottom of the mounting bracket.
2. Rotate canopy slightly until 2 pre-installed screw heads are engaged in the narrow end of key holes.
3. Tighten both screws.

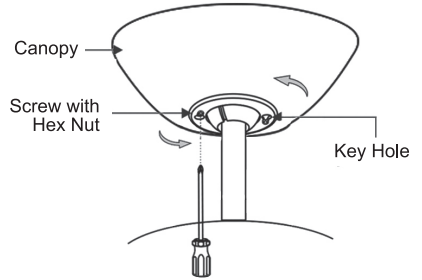

● Canopy Installing for HR Models

1. Screw 4 canopy screws to the mounting bracket.
2. Push up the canopy until the 2 screws on mounting bracket are engaged with L type slot holes on canopy.
3. Rotate the canopy slightly until the 2 screw head are in the L type slot holes.
4. Tighten 4 screws firmly.

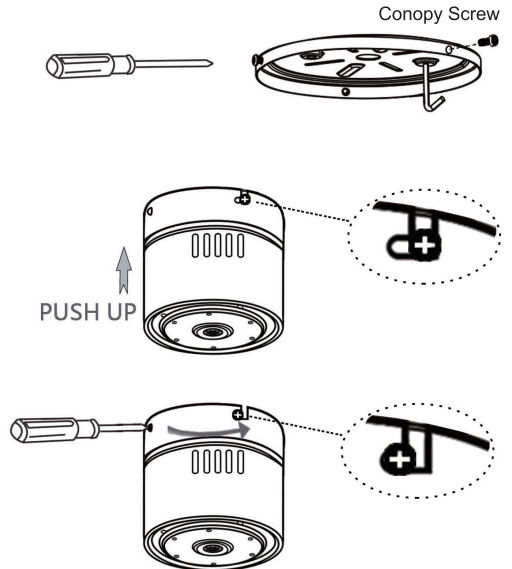

BLADE INSTALLATION: KEN SOLID WOOD

Secure the 3 blades using the screws with lock washer, spring washer and plastic bushing through the holes located on the bottom of the motor assembly.

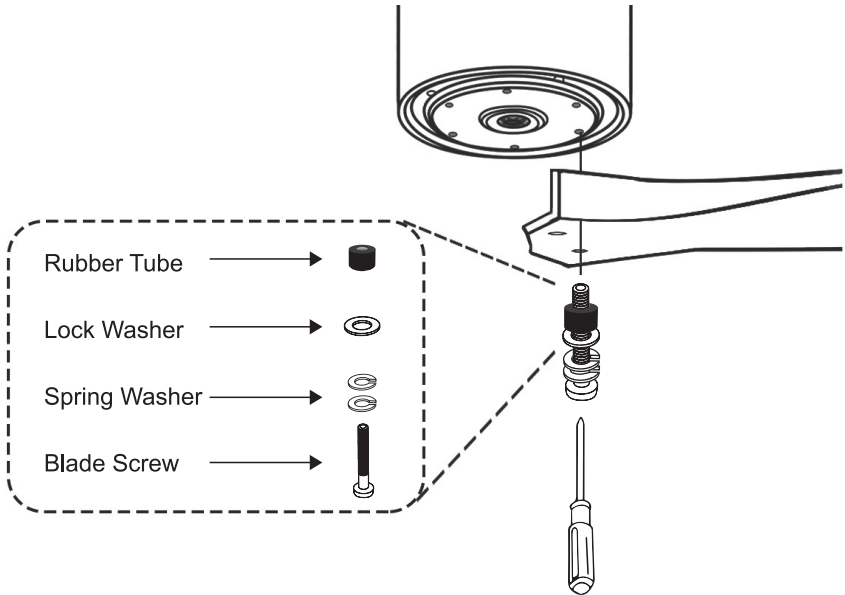

WARNING:

To reduce the risk of serious bodily injury,
DO NOT use power tools to assemble the blades.
If overtightened, blades may crack and break.

REMOTE CONTROL

LEARNING PROCESS

NOTE : The Hand Held Remote Control is equipped with a learning ID function which has code combinations to prevent potential interference from other remote units.

Step: 1. Install 2pcs DC1.5V/AAA batteries in transmitter. Within 30 seconds of turning the Receiver AC power ON, press the transmitter “” button.

Step: 2. Press  about 5 seconds, once the receiver has detected the ID, the receiver will make sound, Bi Bi, twice. This will indicate the receiver has learned the ID that was previously selected on the transmitter

Note: After the AC power is on, do not press any other buttons on the transmitter before touching button. Because doing so will cause the procedure to fail. After completing the steps above, you should be able to operate the ceiling fan and light. If the ceiling fan is not responding to the transmitter, please turn the power off to the receiver and repeat step 1 and 2.

Note: Remove the battery if not used for long periods of time to prevent damage to the hand held remote.

FUCNCTIONS OF TRANSMITTER

1. FAN :

1. Turn on ceiling fan at 1st speed (lowest speed).
2. Turn on ceiling fan at 2nd speed.
3. Turn on ceiling fan at 3rd speed.
4. Turn on ceiling fan at 4th speed.
5. Turn on ceiling fan at 5th speed.
6. Turn on ceiling fan at 6th speed (high speed).

 : Turn off ceiling fan

2. LIGHT:

 ON/OFF — Touch this icon and release instantly to turn on or off the light.

DIMMER — Press and hold over 5 seconds to dim or brighten light to the desired level and release. (Light function setting switch at D position)

 : Touch icon for forward/reverse airflow of ceiling fan.

 : Natural breeze: Fan speed will modulate to simulate a natural breeze.

3. FAN TIMER:

1hr : Setting up that the ceiling fan will turn off after 1 hours automatically.

3hr : Setting up that the ceiling fan will turn off after 3 hours automatically.

6hr : Setting up that the ceiling fan will turn off after 6 hours automatically.

SLIDER SWITCH – D & O for Light function setting

D position – on / off and dimming

O position – on / off only

If installed energy bulbs or undimmable LED lamp onto ceiling fan, please slide the “light function select switch” to O position. If installed tungsten bulbs or dimmable LED lamp onto ceiling fan, please slide the “light function select switch” to D position.

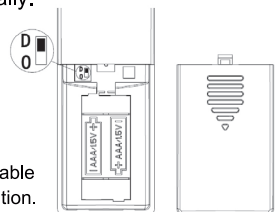
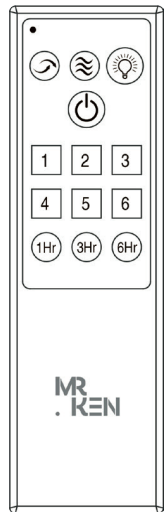

----- Service Center -----

Should you require any assistance, our service center is available at

BRAIN THAI ENTERPRISE CO.,LTD.

4 soi Chaloeprakiat R.9 48 Yaek 11 Dokmai Prawet Bangkok 10250 Thailand

Tel : 02-726-6506 (Auto 6 Line) Fax : 02-726-6707

Call Service Center : 02-726-6505

Website : www.mrken-fan.com

Service Mobile : 094-490-4446

Email : info-service@mrken-fan.com

